

YFS1/D0.12Z22——0.12A 700V SSR

概述 Features

- 过零型 Zero-cross
- 负载电流至0.12A Load current up to 0.12A
- 阻断电压700V Repetitive peak off-state voltage 700V
- 介质耐压2500V Dielectric strength 2500V
- 符合RoHS RoHS compliant

应用 Applications

- 办公设备 Office machine
- 家电产品 Home appliances
- 固态继电器 SSR
- 开关式电源 Switching power supply
- LED灯控制 LED control

打印标志 Marking information

Part number	Package	Marking
YFS1/D0.12Z22	SOP8	0.12Z

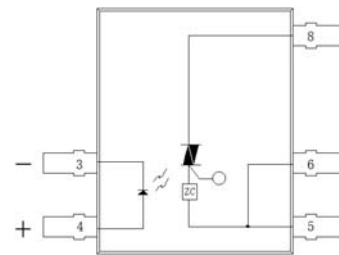

极限值/Absolute maximum ratings

(Ta=25°C)

特性参数/Parameter		符号/Symbol	测试条件/Test condition	最小值/Min.	典型值/Typ.	最大值/Max.	单位/Unit
输入端/Input	LED 反向电压/LED reverse voltage	V_R		6			V
	LED 正向电流/LED forward current	I_F				50	mA
输出端/Output	阻断电压/Repetitive peak off-state voltage	V_{DRM}/V_{RRM}		700			V
	额定电流/On-state RMS current	$I_{T(RMS)}$	$I_{in}=10mA$			0.12	A
	浪涌电流/Surge current	I_{TSM}	50Hz, 1 cycle		1		A
介质耐压/Dielectric strength *		V_{ISO}	$I_{ISO} \leq 0.3mA$	2500			V_{rms}
工作温度/Operating temperature		T_{opr}		-30		85	°C
储存温度/Storage temperature		T_{stg}		-40		125	°C

*: RH=40 to 60%, T=20~30°C, AC for 1minute.

电参数 Electrical parameters

(Ta=25℃)

特性参数/Parameter		符号 /Symbol	测试条件 /Test condition	最小 值 /Min.	典型 值 /Typ.	最大值 /Max.	单位 /Unit
输入端/Input	LED 正向电压 /LED forward voltage	V_F	$I_F=10mA$		1.2	1.3	V
	LED 反向电流/LED reverse current	I_R	$V_R=5V$			10	μA
输出端/Output	断态泄漏电流/Output off-state leakage current	I_{DRM}	$V_{DRM}=700V$			10	μA
	断态泄漏电流/Output off-state leakage current	I_{RRM}	$V_{RRM}=700V$			10	μA
	维持电流/Holding current	I_H				25	mA
	电压指数上升率 /Critical rate of rise of off-state voltage	dv/dt	$V_{DRM}=600V*1/\sqrt{2}$	5			V/ μs
耦合特性 /Transfer characteristics	LED 触发电流/LED trigger current	I_{FT}				8	mA
	推荐的工作电流 /Recommend operating current	I_{in}		10		18	mA
	导通电压降/Output on-state voltage drop	V_T	$I_{in}=10mA,$ $I_L=0.12A$ $V_D=6V$		1.6	2.5	V
	过零电压/Zero-cross voltage	V_{zc}	$I_{in}=10mA,$ $I_L=0.12A$		10	20	V
	导通时间/Turn on time	T_{on}	$I_{in}=10mA,$ $V_D=6V, R_L=100\Omega$			1+1/2cycle	ms
	关断时间/Turn off time	T_{off}				1+1/2cycle	ms

外形尺寸 Outline dimension

1、SOP8

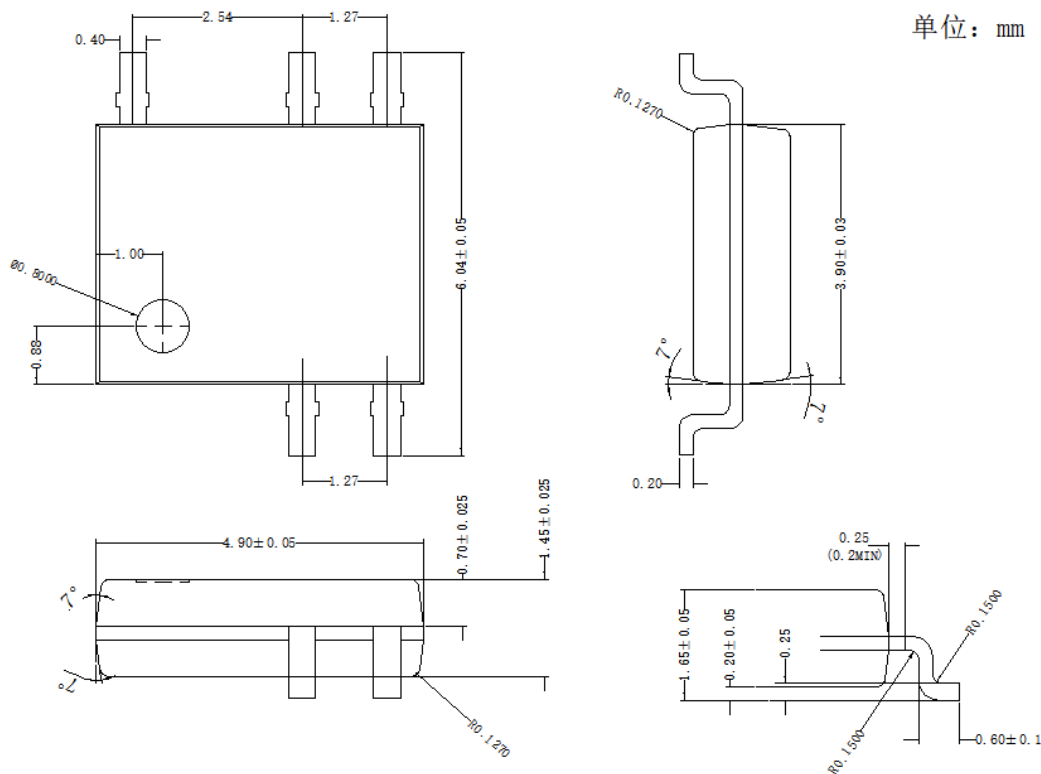

订货信息 Ordering information

订货信息/Ordering information						
	Y	FS1	D	0.12	Z	22
公司商标代号 Company symbol						
SOP8 交流输出型 AC SSR						
输入端电流型 Current driving: D						
负载电流 Load current: 0.12—0.12A						
P:调相型 Non zero-cross Z:过零型 Zero-cross						
负载电压 Load voltage: 22:220Vac;38:380Vac						

包装信息 Package specification

每卷 4000pcs
每盒 8000pcs
每箱 64000pcs

SOP8 Embossed Carrier Tape

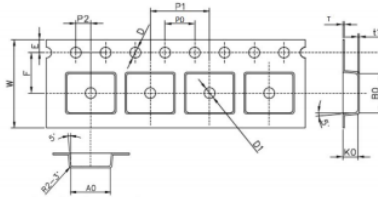

SOP8 Tape Leader and Trailer

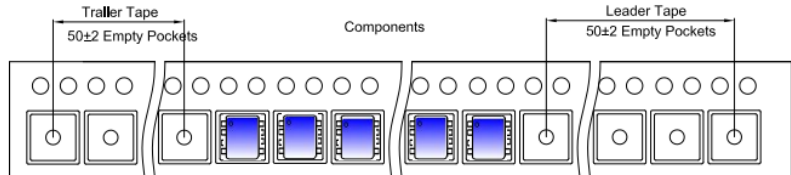

Dimensions are in millimeter										
Pkg type	A0	B0	K0	D	E	F	P0	P1	P2	W
SOP8	6.60	5.30	2.10	Ø1.55	1.75	5.50	4.00	8.00	2.00	12.00

SOP8 Reel

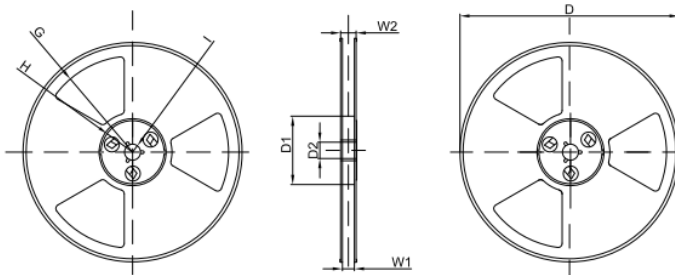



Dimensions are in millimeter							
Reel Option	D	D1	D2	G	H	I	W1
13" Dia	Ø330.00	100.00	13.00	R130.50	R44.50	R6.50	13.00

REEL	Reel Size	Box	Box Size(mm)	Carton	Carton Size(mm)
4000 pcs	13 inch	8,000 pcs	362*332*50	64,000 pcs	460*342*390

Packaging Description:

SOP8 parts are shipped in tape. The carrier tape is made from a dissipative (carbon filled) polycarbonate resin. The cover tape is a multilayer film (Heat Activated Adhesive In nature) primarily composed of polyester film, adhesive layer, sealant, and anti-static sprayed agent. These reeled parts in standard option are shipped with 4,000 units per 13" or 33.0 cm diameter reel. The reels are clear in color and is made of polystyrene plastic (anti-static coated).

图片	名称	代码	尺寸 (mm)		描述
			长	宽*高	
	PS 内盒	H6	36.2	33.2*5cm	纸盒为本色； 表面有防静电标识及可回收标识； 标识为黑色。
	PS 专用外箱	J1	46	34.2*39cm	纸箱为本色； 封口上方有易碎标识（黑色）； 纸箱一侧有 C/NO. 及信息方框 (内容: CUSTOMER、QUANTITY、 MFG. P/N、LOT NO.、DATE CODE、 QA) 黑色； 纸箱一侧有向上标识及信息 (内容 TYPE:、QTY: Kpcs、 N.W: KGS、G.W: KGS)。

安规要求 Safety and insulation ratings

爬电距离	Creepage distance	3.5mm, CTI \geq 275;
瞬时过电压	Highest allowable overvoltage	5000V;
再现峰值电压	V_{IORM}	769V;
局部放电	Partial discharge test voltage : method b, $V_{Pd} = V_{IORM} \times 1.6$	1230V.

特性曲线 Characteristic data

1. 负载电流与环境温度关系曲线

Load current VS. ambient temperature

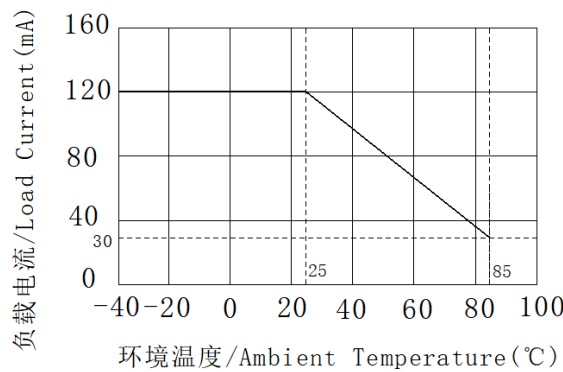

2. 导通压降—环境温度特性

On-state voltage drop VS. ambient temperature

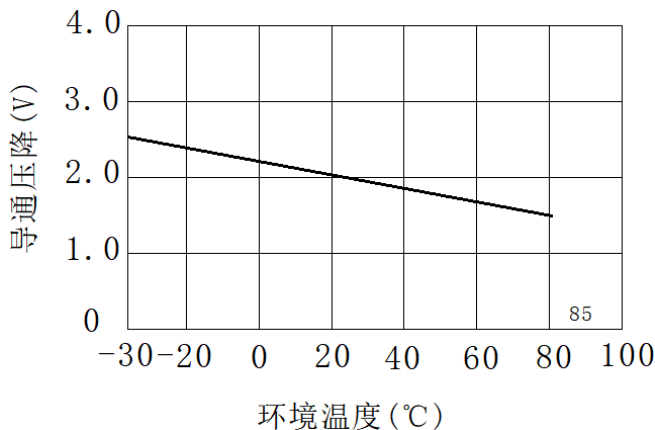

3. LED触发电流—环境温度特性

Trigger LED current VS. ambient temperature

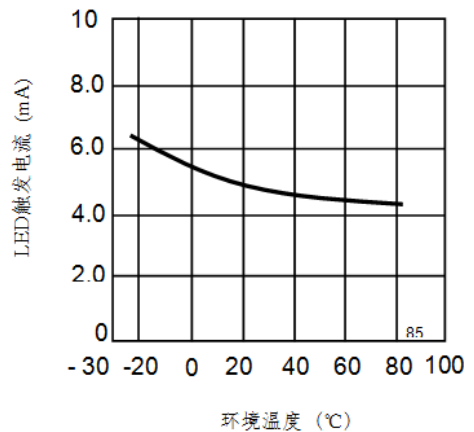

4. LED 导通压降—环境温度特性

LED dropout voltage vs. ambient temperature
LED current: 10 to 50 mA

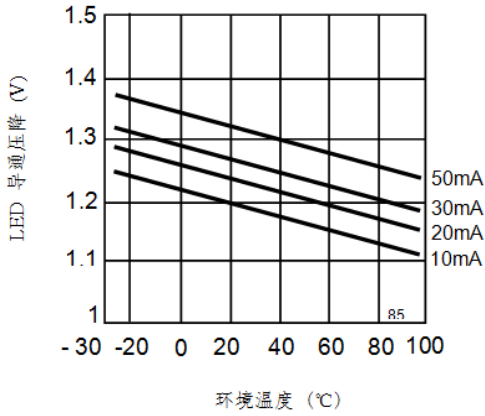

5. 导通时间—LED 电流特性

Turn on time vs. LED current

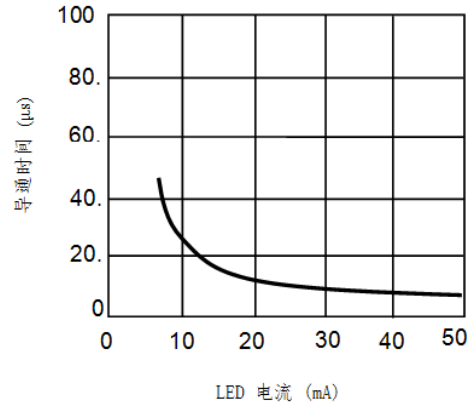

接通和关断时间关系 Turn on and turn off time

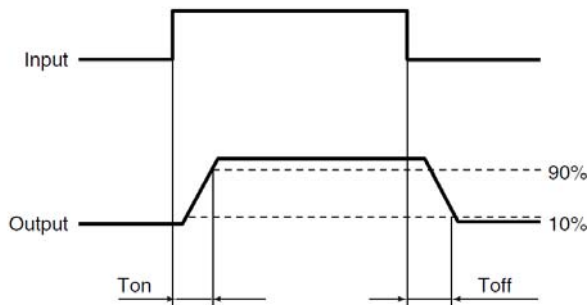

接线图 Wiring diagram

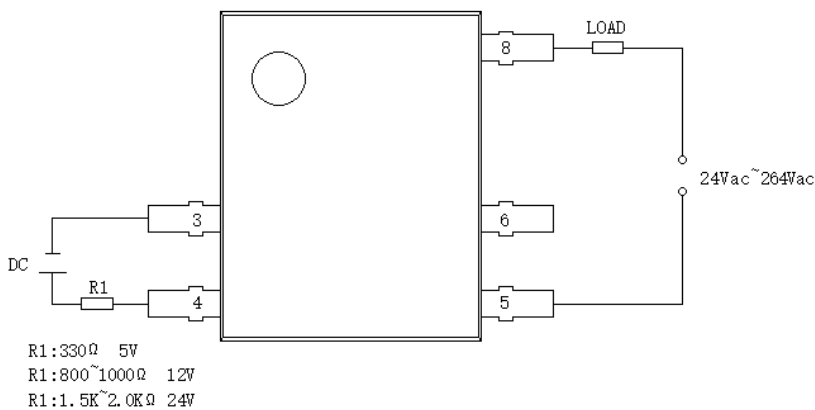

注意事项 Notes

- a) 工作环境温度超过 25℃时请降额使用。参见特性曲线 1。
When ambient temperature is above 25℃, the load current must be reduced. (see characteristic data 1)
- b) 继电器接线时，务必保证输入端极性的正确，以免损坏继电器。
Ensuring the polarity is correct when connecting the input lines, otherwise the wrong connection will damage the relay.
- c) 由于 SSR 动作时间很短，输入端的噪声可能会引起 SSR 误动作，所以在输入端环境噪声较大时，应在输入端接 R/C 回路吸收噪声。
Since the operate time of the relay is extremely short, any noise to input terminal will cause malfunction of the SSR, So a RC circuit should be connected to input terminal to absorb the noise in the noisy condition.

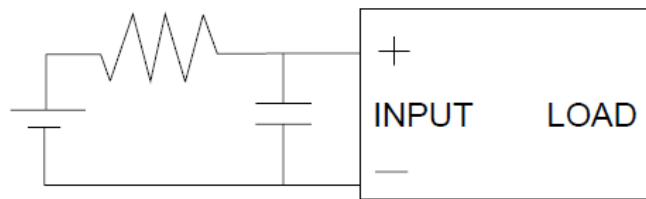

- d) 推荐的使用电路，输出端的尖峰电压可能会引起 SSR 误动作，所以请在输出端加 R/C 回路或压敏电阻吸收尖峰电压，具体见下图：
Below shows a recommend circuit: Please add a RC circuit or varistor on the load side, as noise/surge could damage the unit or cause malfunctions.

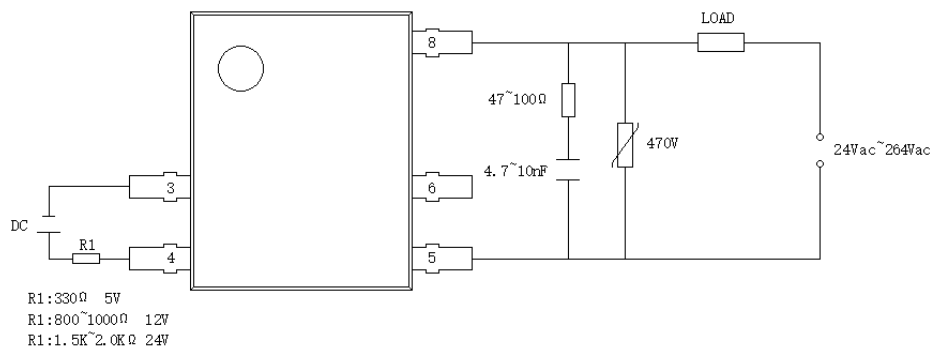

关于防静电对策 Cautions for static electricity

- a. 使用电烙铁时，对电烙铁前端进行接地。(建议使用低电压用的电烙铁。) When using soldering irons, either use irons with low leakage current, or ground the tip of the soldering iron. (Use of low-voltage soldering irons is also recommended.)
- b. 组装时使用的设备等也应正确的接地。Devices and equipment used in assembly should also be grounded.

关于焊接 Soldering

继电器焊接, 260℃情况下焊接时间不能超过 10 秒钟, 350℃情况下焊接时间不能超过 5 秒钟。
Soldering must be completed within 10 seconds at 260℃ or within 5 seconds at 350℃.